

The SB1i is a rugged, all-weather sensor package providing a robust 2-wire 4...20mA output.

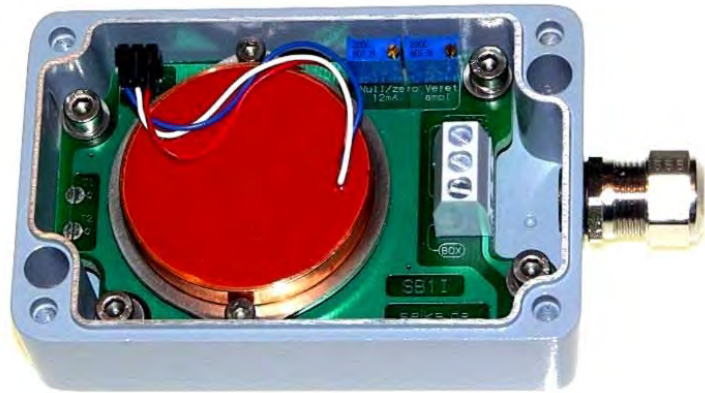

Features

- *Die-cast Aluminum housing with sea water resistant finish*
- *Environmental Protection up to IP67*
- *Housing designed for extra stable sensor platform*
- *4...20mA amplifier for 2-wire connection*
- *Temperature compensation beyond the sensors own compensation data*
- *No extra power required*
- *Customer specified angle ranges*
- *Sensor and amplifier are galvanically separated from the housing*
- *Extensive EMC protection*
- *Highly stable sensor supply voltage*
- *Dynamic parameters are programmable*
- *Current-loop with maximum current limitation*
- *High overload resistance*
- *Reverse polarity protected*
- *Low-pass signal filter with optional setting of maximum frequency for suppression of interference frequencies*

Description

The SB1i sensor unit is packaged in a solid and compact pressure-cast Aluminum housing with an integrated sensor for single axis inclination or acceleration measurements.

Within the box are 2 sections: An amplifier with a 4...20mA output signal - allowing a 2-wire system; and a separate highly stable power supply for the sensor. The amplifier contains a low-pass filter for upper frequency limitation, with noise suppression filtering and a diode bridge for the unipolar current-loop operation. Both sensor and amplifier are galvanically isolated from the housing - further reducing susceptibility to outside noise. Specific response time constants and maximum current output limitations are additional options.

For a higher degree of accuracy, an NG-type sensor can be integrated into the SB1i box, which considerably reduces temperature drift over the entire temperature range. Add a strong metal PG cable fixing combined with the 2-wire current-loop output the SB1i provides a high-quality system for use under many types of harsh working conditions.

Applications

The SB1i is used where inclination or acceleration measurements need to be combined with a 4...20mA current-loop output: especially where noise and/or distance to source are a concern. Typically used in building and bridge construction, mining, radar alignment systems, pitch and roll, agricultural equipment, and all types of process machinery.

TECHNICAL DATA	
Termination/Cable Diameter	max.: 3 x 1.5 mm ²
Cable Fixing	M12 x 1.5 cable gland; clamping range 6...7mm
Measuring Ranges	In accordance with the actual sensor
Protection Degree	IP65
	IP67 with RTV fill
Mounting	Any direction
Inclinometer Measuring Plane	N Series: 3 directions of mounting
	NG Series: Parallel to the base of housing (default)
Accelerometer Measuring Directions	B, BDK Series: Place in X, Y, Z co-ordinates to the housing
Supply voltage to the box	+10...+30VDC
Minimum loop current	3mA
Maximum loop current	22...26mA
Output current loop signal	4...20mA (12mA as zero point)
Adjustable parameters via potentiometers	Signal-zero (12mA), Span
Max. Load impedance	500 Ohm (at 24 Volt loop supply)
Operating temperature	-40...+85°C
OPTIONS	
Special measuring ranges, test report, custom wiring	
<p>The SB1i Sensor Box is extremely versatile, allowing various configurations with other Rieker sensors. If you have an application that requires alternative specifications, one of our engineers will be happy to discuss how to customize the box for your inclination or acceleration needs.</p>	

FIGURE 1: Dimensions and Mounting Position

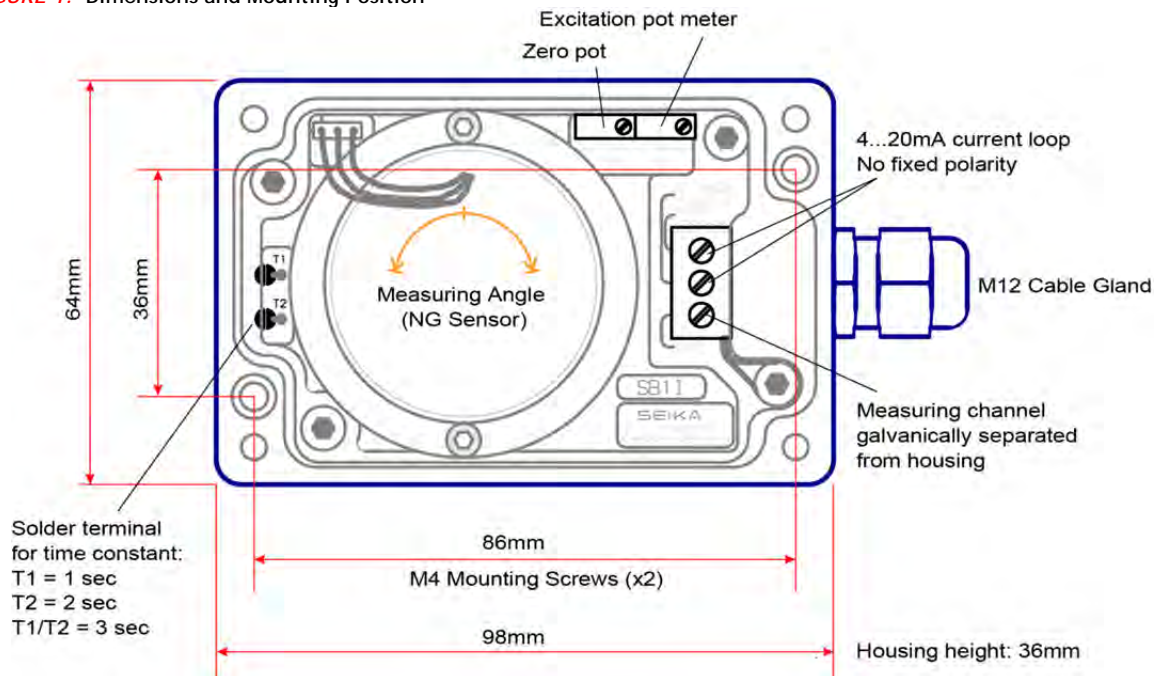

FIGURE 2: Dimensions and Mounting Position
(Shown with N- or NB-type inclinometer sensor or B- or BDK-type Accelerometer)

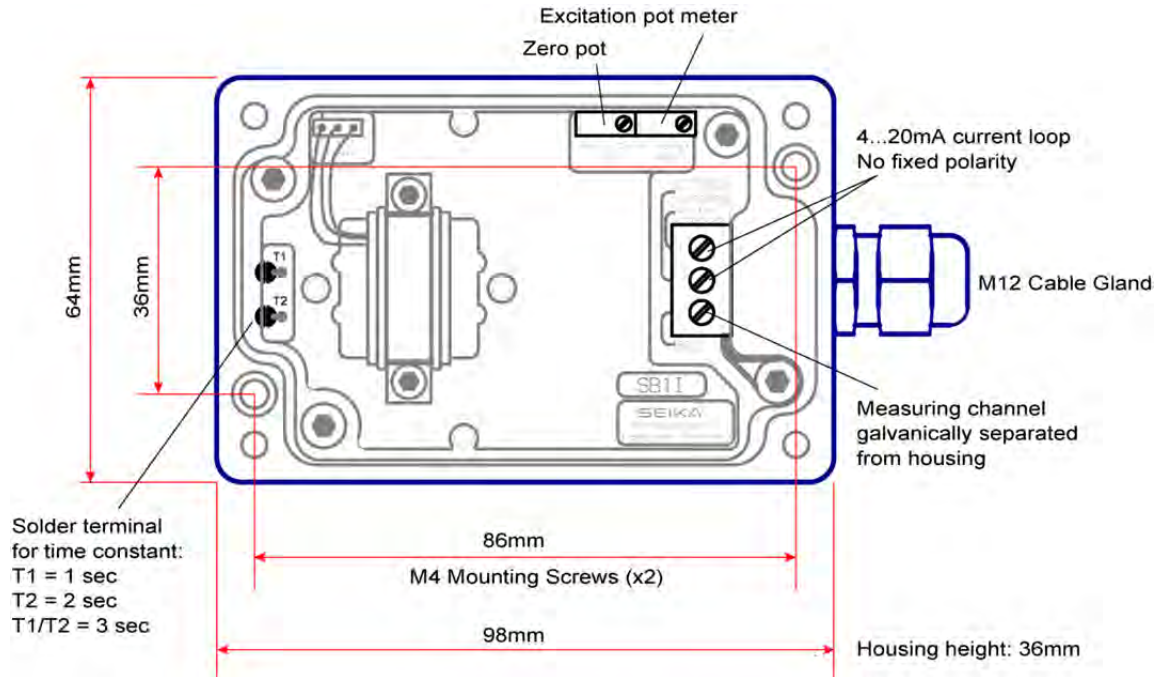
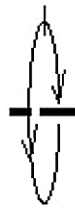

FIGURE 3: Measuring Level and Rotation Directions

Sensor Type: N, NB, B, BD, BDK



N-type Sensor

Angle zero can be (\pm) rotated in both directions.

Cable output from the sensor box can be from the right (as shown), from the left, or the top. The NG-types have similar measuring directions.

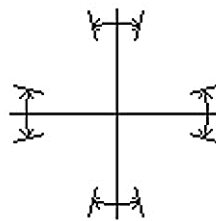

NB-type Sensor

Zero point mountable in 90° steps.

Rotation in both directions possible.

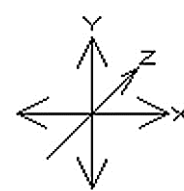

B, BD, BDK-type Sensors

Acceleration measurement is possible in X, Y, and Z direction through corresponding mounting position.

\pm measuring possible in X and Y directions.

The above diagrams demonstrate the feasibility of measuring most angles of inclination and directions of acceleration with SB1i sensor packages. With so many choices, we'd be happy to advise you. Contact us today, one of our application experts would be happy to speak with you. A sketch of your application would be helpful as necessary.

FIGURE 4: Block Diagram and Wiring Connections

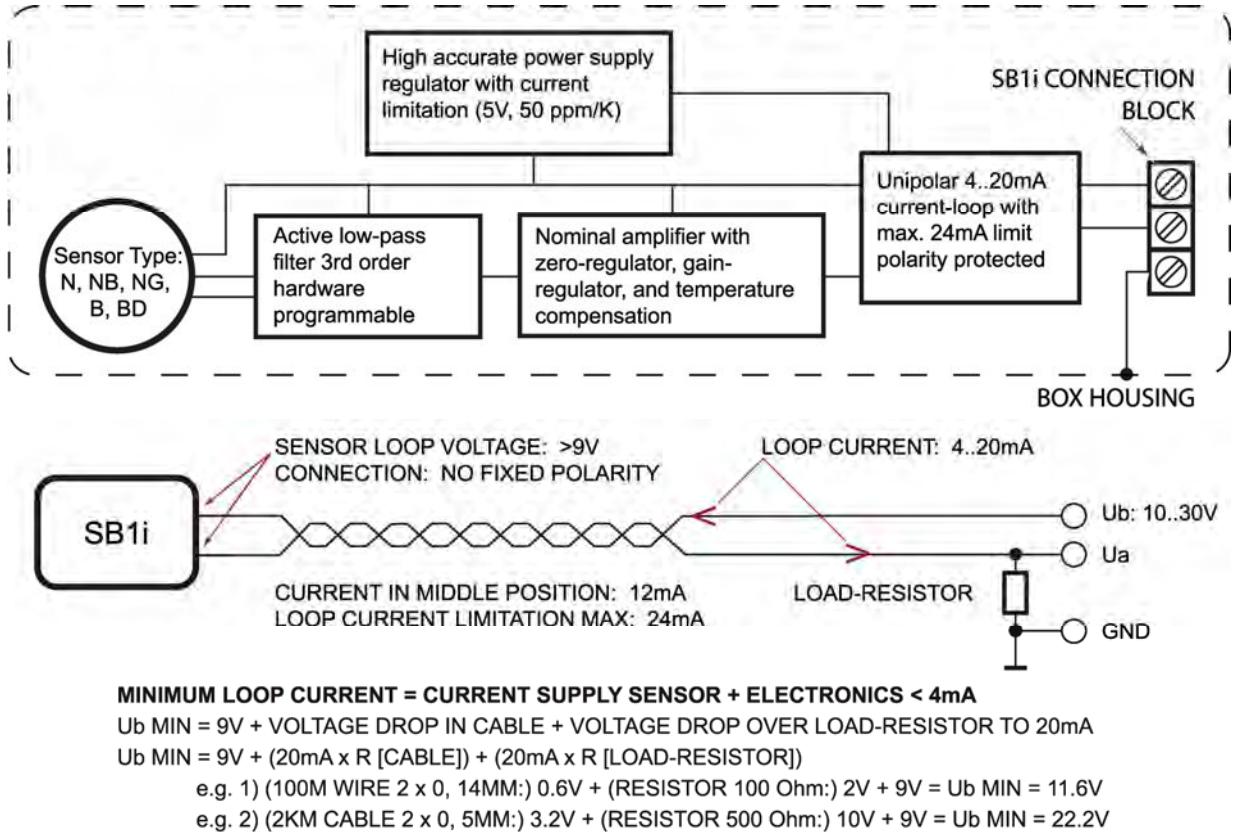

NOTES: Since the supply voltage for the SB1i is obtained from the current-loop and requires a max. 3mA, an input voltage of 9 Volts/min. must be present at the connection block. This is also required in order to guarantee correct operation when the highest loop current of approximately 24mA is used.